



Überfahrbar / Traversable

ABS-Lock[®] SYS II+IV



MoA 243-05



Werkzeuge | Tools

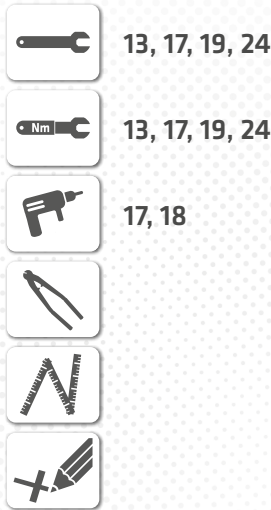

Sicherheitshinweise | Safety instructions



- DE** Die Anweisungen der Montageanleitung (1) und Sicherheitshinweise (2) sind strikt einzuhalten.
- EN** The information contained in the assembly instructions (1) and safety instructions (2) must be strictly observed.
- NL** De aanwijzingen in de montagehandleiding (1) en de veiligheidsvoorschriften (2) moeten strikt worden nageleefd.
- ES** Respete estrictamente las instrucciones del manual de montaje (1) y las indicaciones de seguridad (2).
- IT** È assolutamente necessario attenersi alle istruzioni di montaggio (1) e alle norme di sicurezza (2).
- FR** Les instructions de la notice de montage (1) et les consignes de sécurité (2) doivent être formellement respectées.
- PL** Należy ściśle przestrzegać instrukcji montażu (1) i wskazań bezpieczeństwa (2).
- DK** Montagevejledningens (1) anvisninger som også sikkerhedshenvisningerne (2) skal overholdes.
- CZ** Je nutné striktně dodržovat instrukce obsažené v montážním návodu (1) a v bezpečnostních pokynech (2).
- GR** Πρέπει να τηρούνται αυστηρά οι οδηγίες του χειριδίου συναρμολόγησης (1) και των υποδείξεων ασφαλείας (2).
- SK** Dôsledne dodržiavajte pokyny montážneho návodu (1) a bezpečnostné pokyny (2).
- TR** Montaj kılavuzunun (1) ve güvenliik uyarılarının talimatlarına (2) kesinlikle uyulmalıdır.
- NO** Det er svært viktig at instruksjonene i monteringshåndboken (1) og sikkerhetsheftet (2) følges.
- RUS** Необходимо строго соблюдать требования руководства по монтажу (1) и инструкции по безопасности (2).
- RO** Indicațiile din instrucțiunile de montare (1) și din broșura cu indicații de siguranță (2) trebuie respectate cu strictețe.
- FI** Asennusohjeen (1) ja turvaohjevhikosen (2) ohjeita on ehdottomasti noudatettava.
- SE** Anvisningarna till monteringsanvisningen (1) och säkerhetsmanualen (2) måste iakttas under alla omständigheter.
- HI** इंस्ट्रक्शन के निर्देशों (1) और सुरक्षा निर्देश मैनुअल (2) में दिये गये निर्देशों का सख्ती से अनुसरण किया जाना चाहिए।
- ZH** 必须严格遵守装配说明书 (1) 和安全须知单 (2) 中的指示。
- SQ** Jëpb alntëzãm baltëclimët wawrdë në fillim të kompozitimit (1) dhe të këmbështimit të sigurtë (2) të mënymës së duhur.

Kontakte | Contact persons

Vertrieb & Technische Beratung
Sales & Technical Support
+49 (0) 28 32 - 972 81 - 0
vertrieb@absturzicherung.de

Schulung
Training
+49 (0) 28 32 - 972 81 - 254
schulung@absturzicherung.de

Montagevorbereitung
Assembly
+49 (0) 28 32 - 972 81 - 260
service@absturzicherung.de

Mustertypenschild | Sample label

[ABS]

ABS SAFETY GMBH 3

Kevelaer, Germany
info@absturzicherung.de
www.absturzicherung.de

Mustertypenschild /
Sample only

Chargennummer /
Batch number

6 Normen / Standards

7 Max. Nutzer gleichzeitig (DIN EN 795:2012)
Max. No. of simultaneous users

11 Modellnummer / Model number

 -

 -

 -

 -

 -

4

5

8

9

10



Montageschritte dokumentieren

Document assembly step

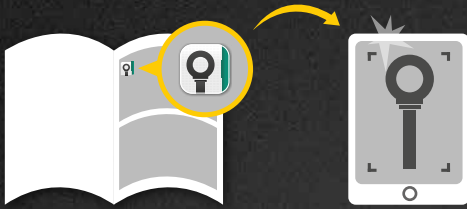

abs.lock-book.com

Inhalt | Content



12

ABS Systemschild /
ABS specification plate



13

ABS SP



14

ABS TI-Bracket



15

ABS Gabelkopf
(aufgewalzt) / ABS clevis
(rolled on)



15

ABS ForceLimiter



16

ABS TI-FlexCurve



18

Befestigung für Fassaden-
kurven / Attachment for
facade corners



21

ABS Spannelement / ABS
tensioning element



24

ABS CompactForce





↔ 2 - 10
m

ABS ForceLimiter

Gerades System / straight system

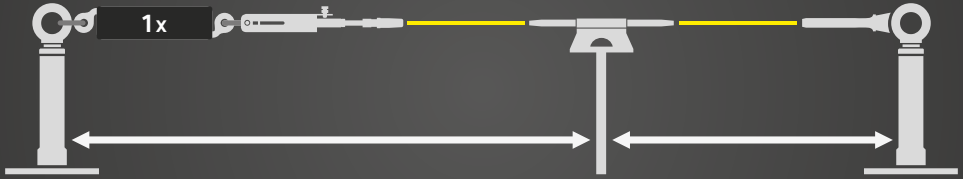

↔ 2 - 10
m

ABS ForceLimiter

Mit Kurven / with curves

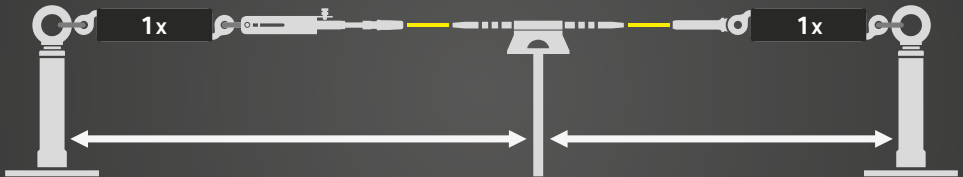



max.
10
m

ABS ForceLimiter

Gerades System (starres System) / straight system (stiff system)

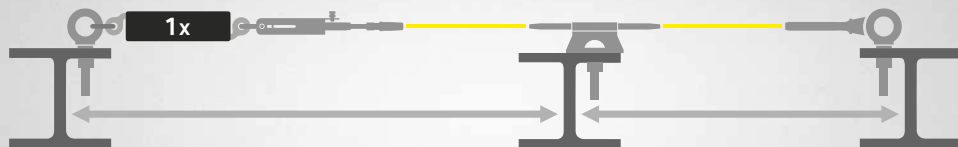

max.
10
m

ABS ForceLimiter

Mit Kurven (starres system) / with curves (stiff system)

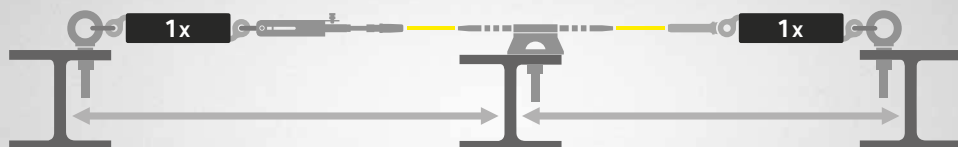

max.
10
m

ABS ForceLimiter

Mit Stützen (weiches System) / with posts (soft system)

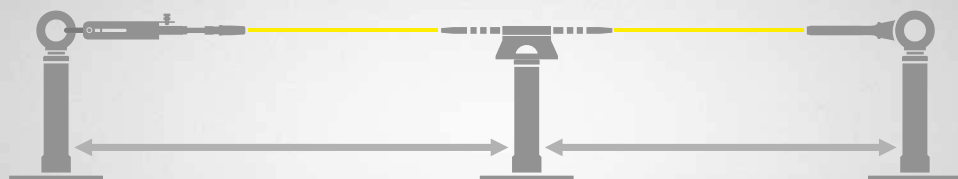

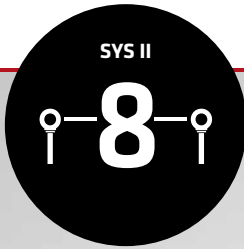

ABS TI-FlexCurve
Seite / Page 16



ABS TI-FlexCurve
Seite / Page 16



ABS ProSlide
SY-PROSLIDE

ABS Systemschild /
ABS specification plate
Seite / Page 12



ABS TI-Bracket
Seite / Page 14



ABS Gabelkopf (aufgewalzt) /
ABS clevis (rolled on)
Seite / Page 15



ABS SP
Seite / Page 13

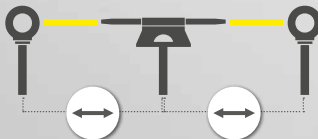



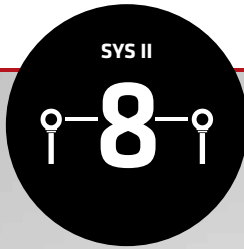

ABS TI-Bracket
Seite / Page 14



ABS CompactForce
Seite / Page 24



ABS ForceLimiter
Seite / Page 15



ABS SkyRoll
SY-SKYROLL

max.
10
m

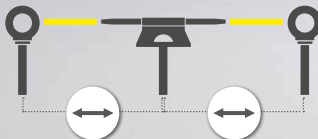

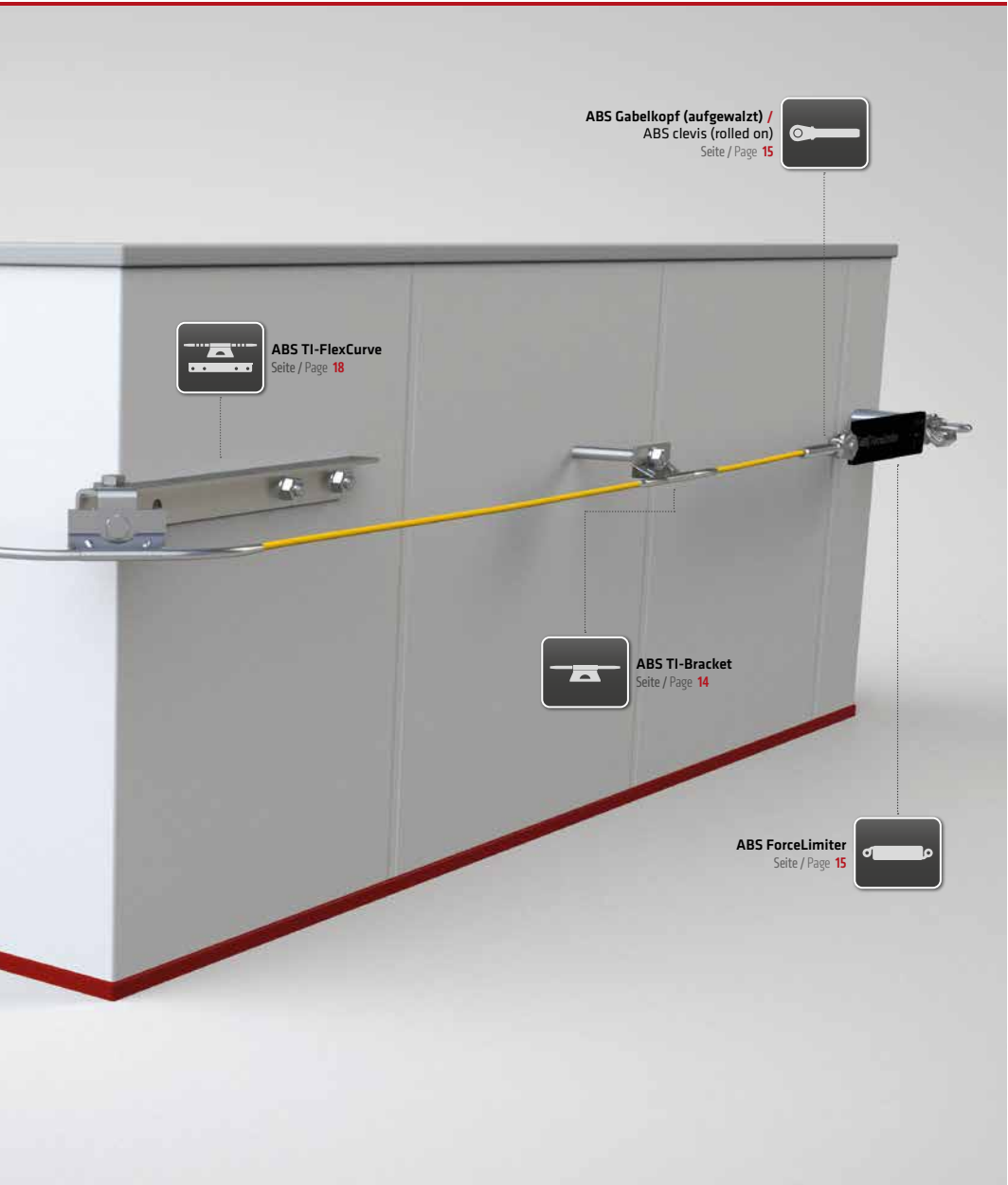

ABS TI-FlexCurve
Seite / Page 18



ABS TI-Bracket
Seite / Page 14



**ABS Gabelkopf (aufgewalzt) /
ABS clevis (rolled on)**
Seite / Page 15



ABS ForceLimiter
Seite / Page 15



 **Biegen per Hand**
Bend by hand



• Nm  50 Nm



a
• Nm  24
 70 Nm

b
• Nm  24
 45 Nm

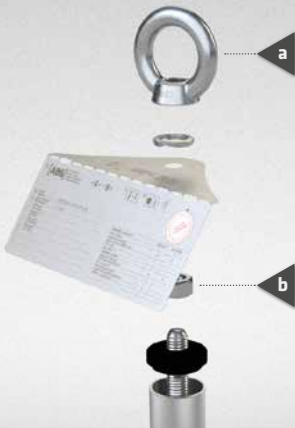



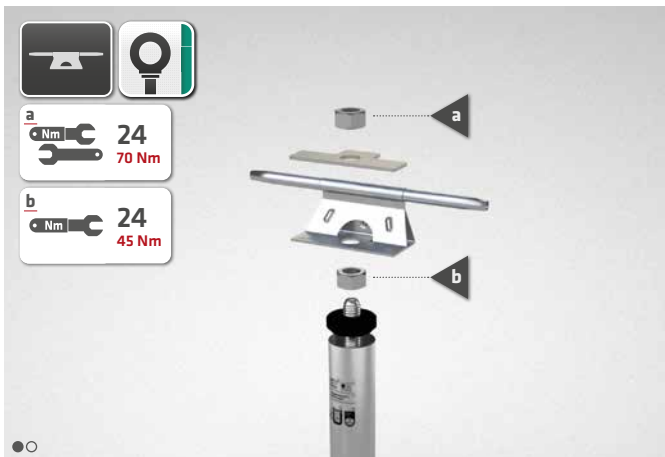

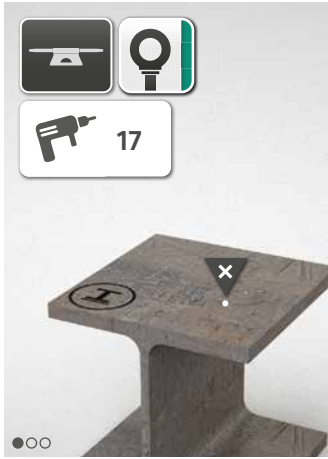



Biegen per Hand nur in Richtung der Schlitze
Bend by hand only in direction of the slots

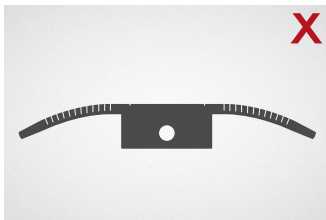
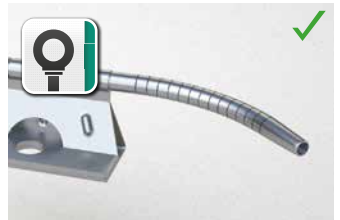
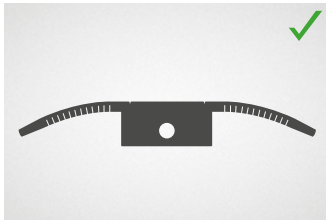

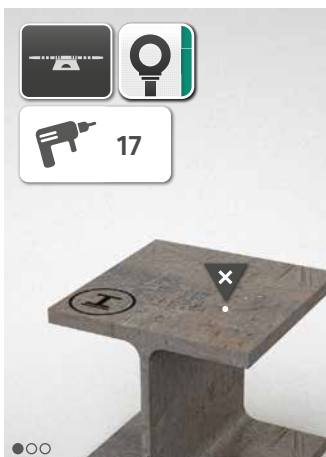

18 | Befestigung für Fassadenkurven / Attachment for facade corners

SV-1016-FA

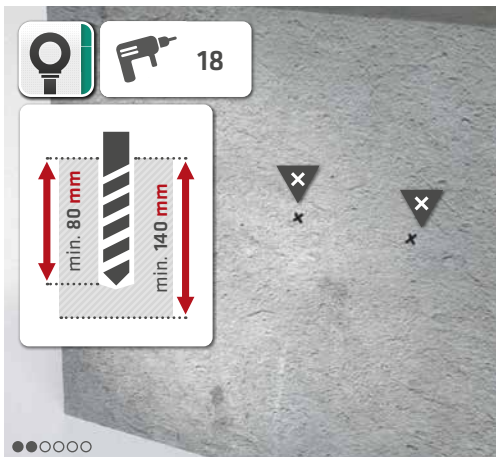
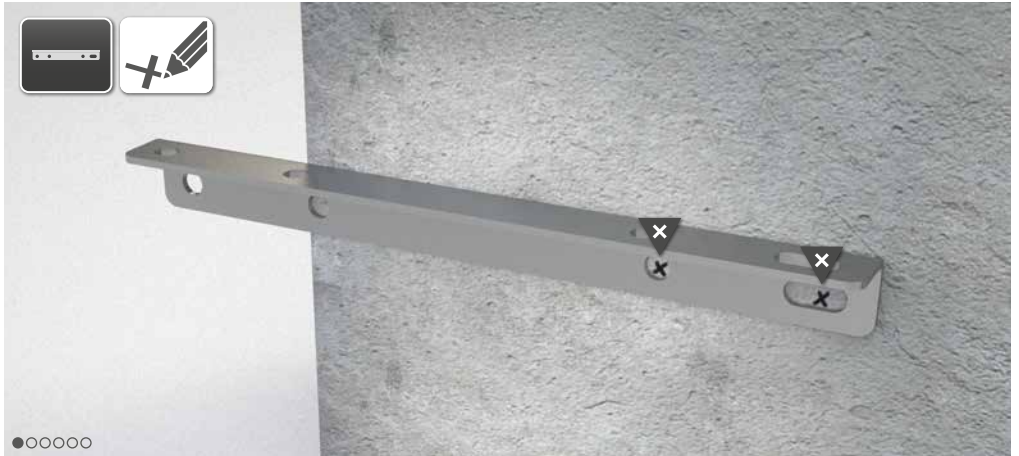
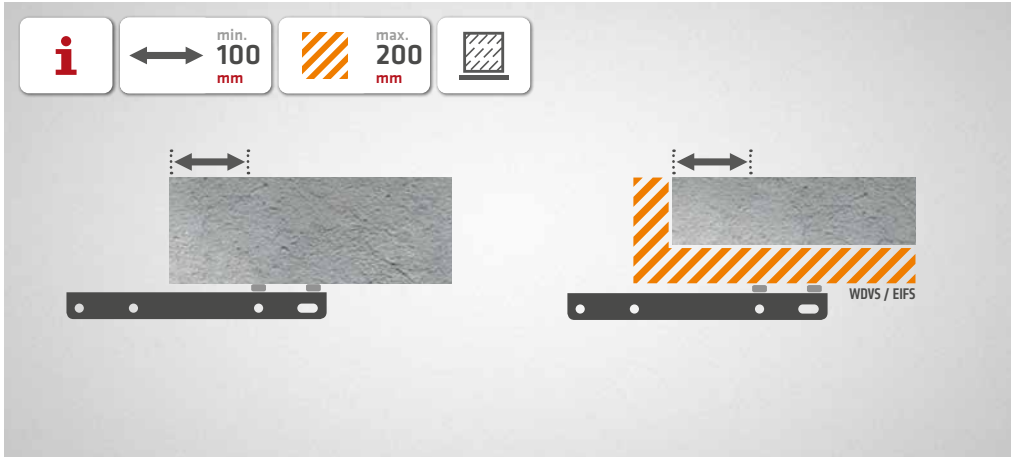



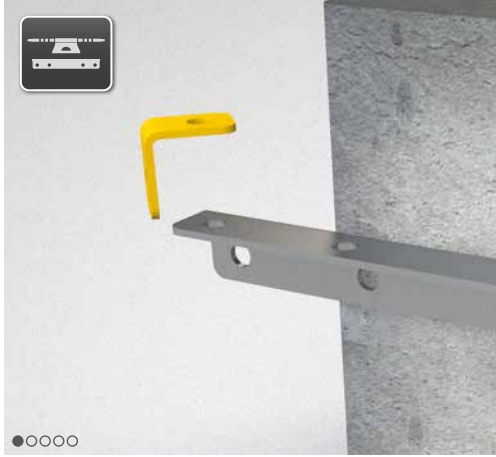

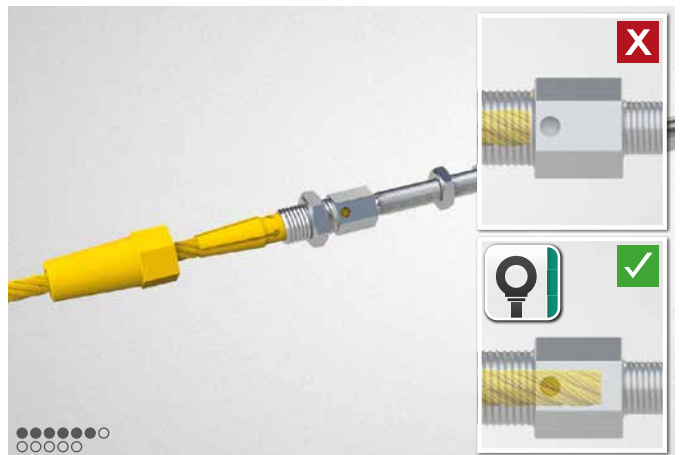
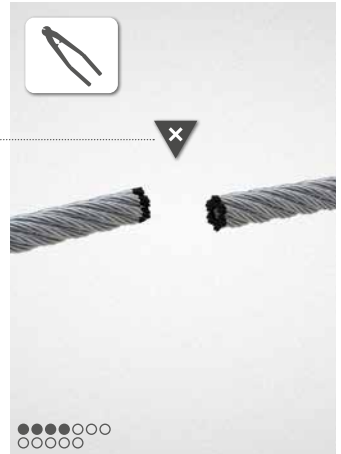
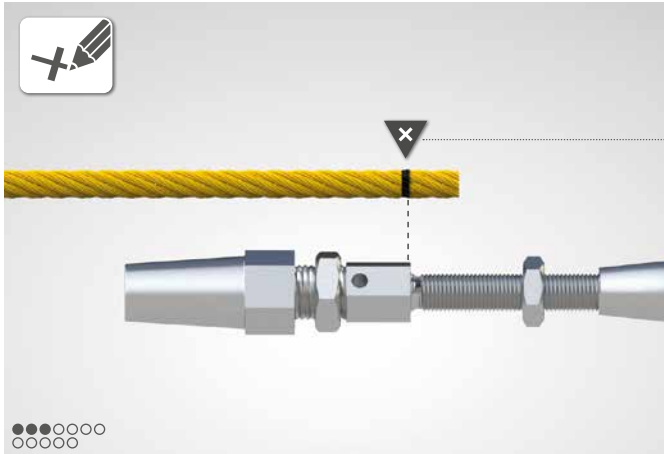
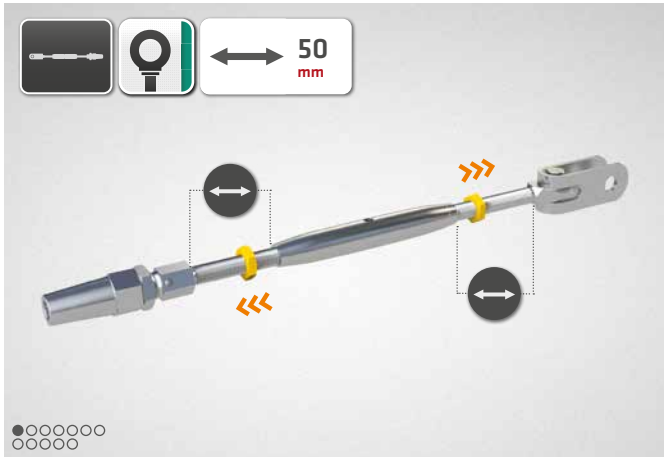

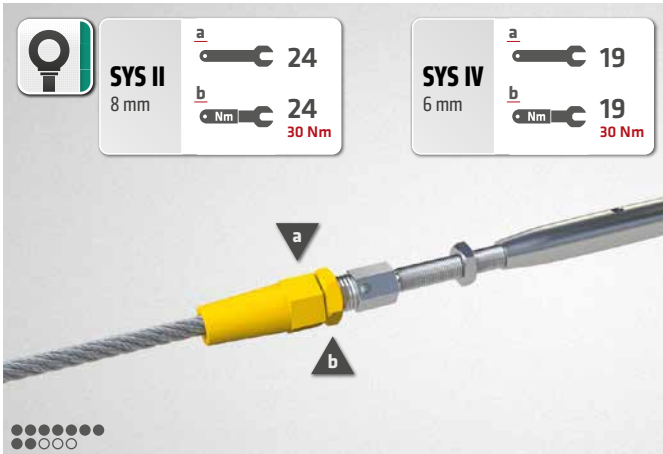

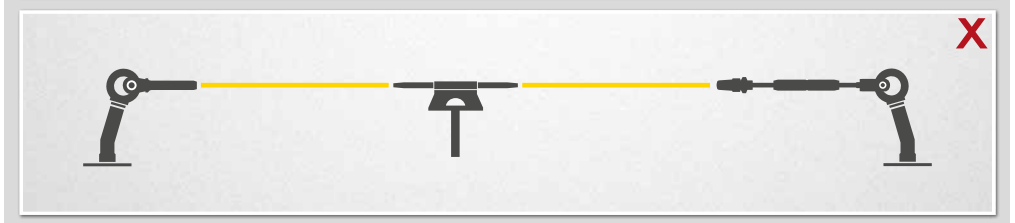
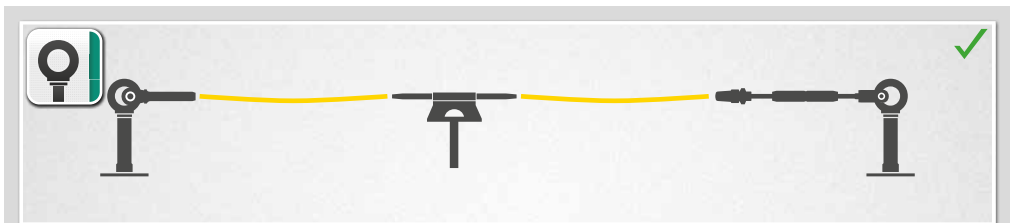
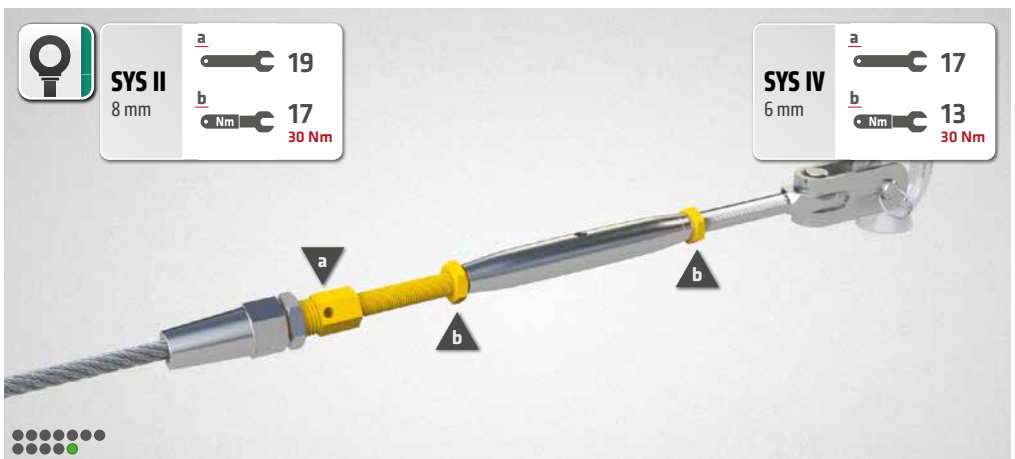
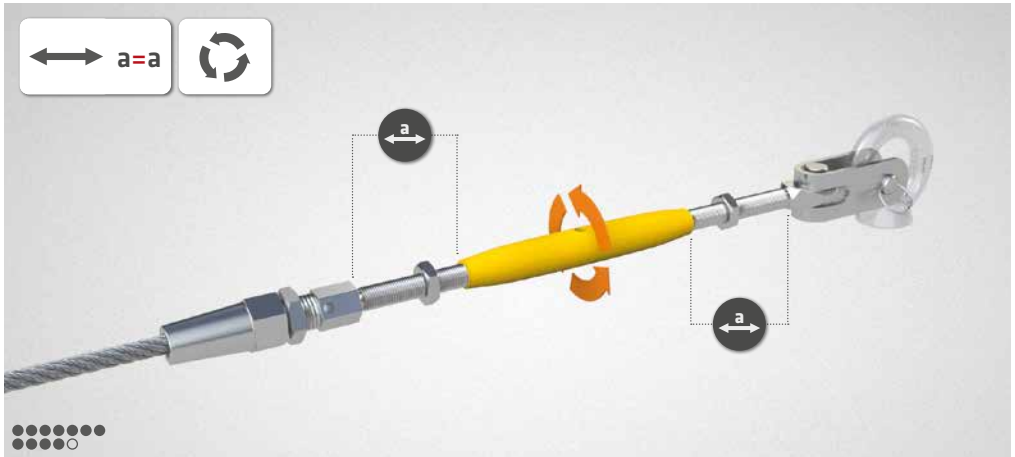

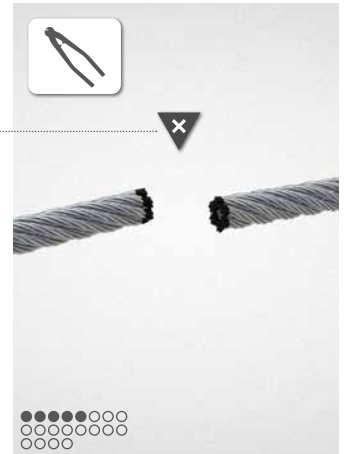
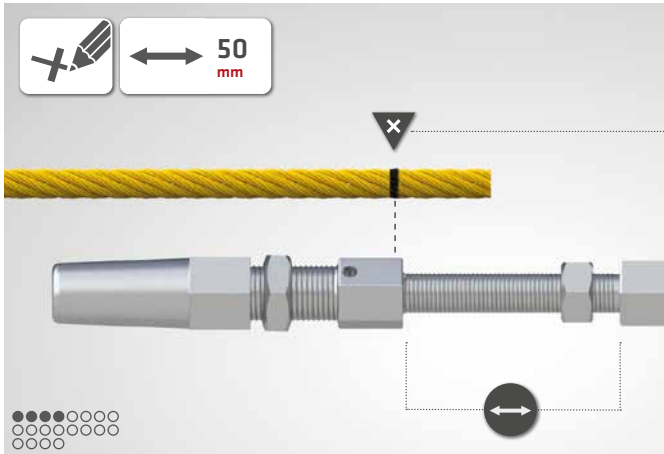
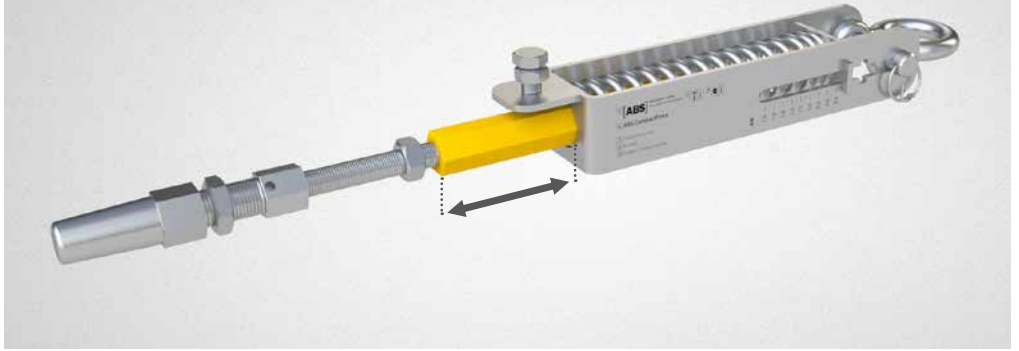

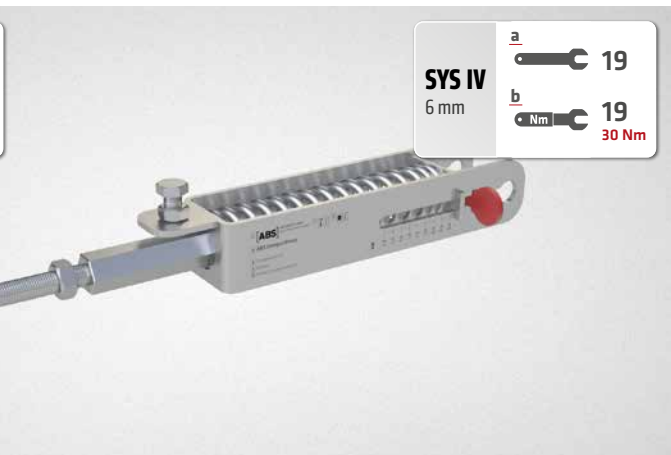
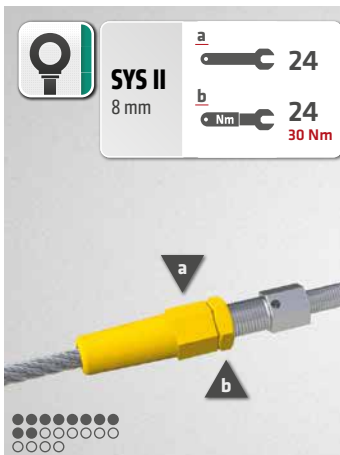
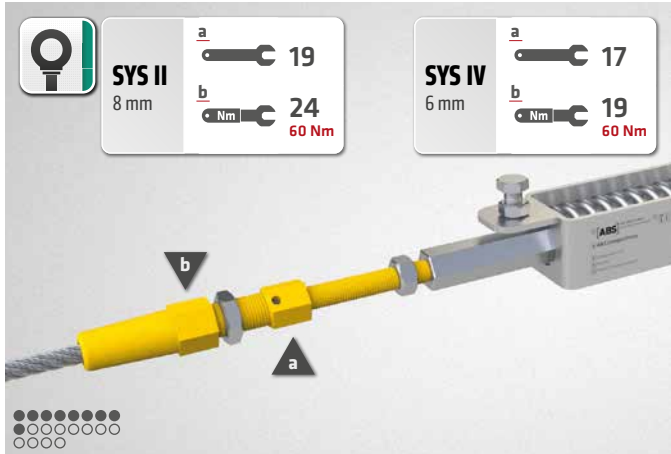



• Nm 13

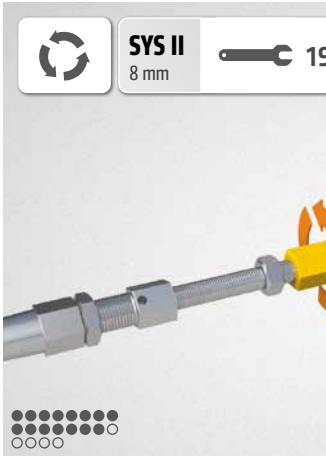

SYS II
8 mm

19

SYS IV
6 mm

17



✓ 0,4 - 0,6
kN

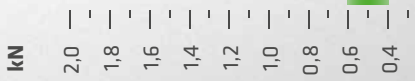
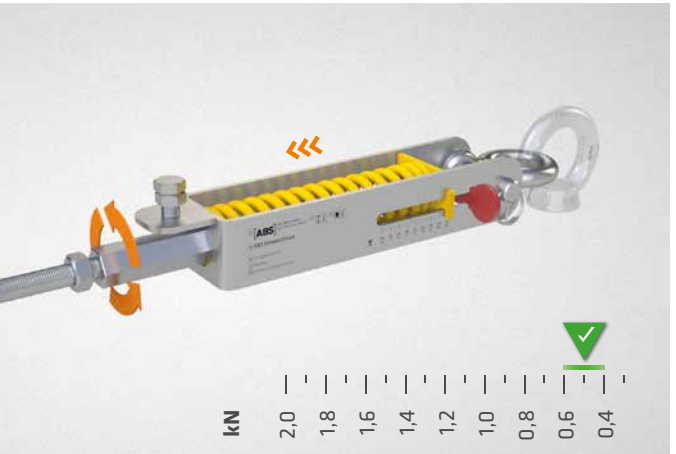



SYS II	a	19
8 mm	b	19 30 Nm

SYS IV	a	17
6 mm	b	17 30 Nm

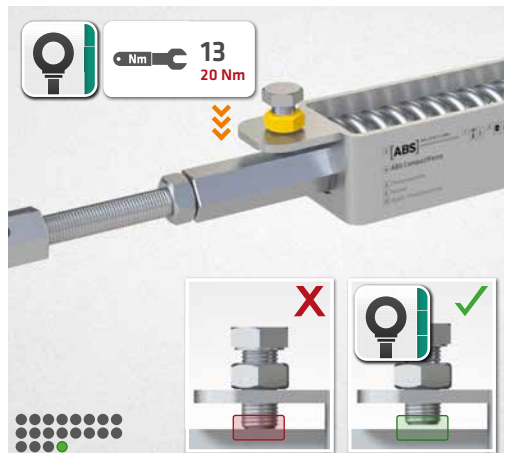
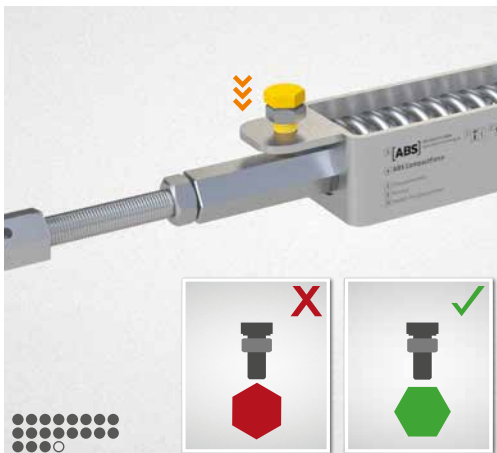
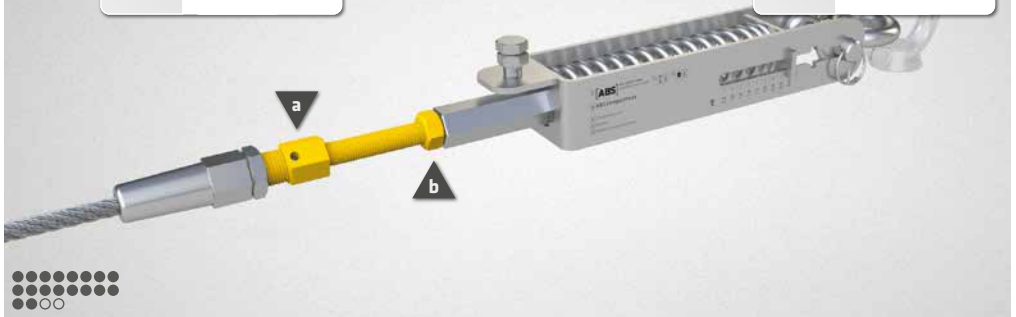

ALWAYS ON TOP!

ABS Safety GmbH

Gewerbering 3
D-47623 Kevelaer
Germany

Tel.: +49 (0) 28 32 - 972 81 - 0
Fax: +49 (0) 28 32 - 972 81 - 29

info@absturzsicherung.de

www.absturzsicherung.de
www.protection-anti-chute.fr
www.fall-arrest.eu

RS 9 Januar 2020



[instagram.com/abssafety](https://www.instagram.com/abssafety)



[youtube.com/abssafetygmbh](https://www.youtube.com/abssafetygmbh)



[facebook.com/ABS.Safety](https://www.facebook.com/ABS.Safety)